

# Panasonic

## Operating Instructions

Microwave Oven  
Models NN-S950  
NN-S750



This manual contains Safety Instructions, Operating Instructions and Maintenance of the oven.

Before operating this oven, please read these instructions completely.

Antes de operar este producto, lea este instructivo en su totalidad.

El manual de instrucciones en español puede ser encontrada en la páginas 19-25

(Spanish Operating Instructions can be found on pages 19-25)

For assistance, please call :1-800-211-PANA(7262)

or send e-mail to :consumerproducts@panasonic.com

or visit us at [www.panasonic.com](http://www.panasonic.com)

(U.S.A)

For assistance, please call : 787-750-4300

or visit us at [www.panasonicpr.com](http://www.panasonicpr.com)

(Puerto Rico)

## PRECAUTIONS TO AVOID POSSIBLE EXPOSURE TO EXCESSIVE MICROWAVE ENERGY

- (a) Do not attempt to operate this oven with the door open since open-door operation can result in harmful exposure to microwave energy. It is important not to defeat or tamper with the safety interlocks. Under normal conditions oven will not operate with door open.
- (b) Do not place any object between the oven front face and the door or allow soil or cleaner residue to accumulate on sealing surfaces.
- (c) Do not operate the oven if it is damaged. It is particularly important that the oven door close properly and that there is no damage to the:
  - (1) door (bent),
  - (2) hinges and latches (broken or loosened),
  - (3) door seals and sealing surfaces.
- (d) The oven should not be adjusted or repaired by anyone except properly qualified service personnel.

### Technical Specifications

	NN-S950	NN-S750
Power Source:	120 V, 60 Hz	120 V, 60 Hz
Power Consumption:	11.5 Amps, 1,320 W	11.5 Amps, 1,320 W
Output:*	1,300 W	1,300 W
Outside Dimensions (H x W x D):	14" x 23 7/8" x 19 9/16" (356 x 606 x 497mm)	11 15/16" x 21 7/8" x 19 9/16" (304 x 555 x 497mm)
Oven Cavity Dimensions (H x W x D):	10 15/16" x 18 7/16" x 18 1/2" (278 x 469 x 470mm)	9" x 16 7/16" x 18 1/2" (228 x 418 x 470mm)
Operating Frequency:	2,450 MHz	2,450 MHz
Uncrated Weight:	Approx. 36.6 lbs. (16.6 kg)	Approx. 32lbs. (14.3 kg)

\*IEC 705-88 Test procedure

Specifications subject to change without notice.

The serial number of this product may be found on the back side of the oven. You should note the model number and the serial number of this oven in the space provided and retain this book as a permanent record of your purchase for future reference.

Model No. \_\_\_\_\_

Serial No. \_\_\_\_\_

Date of Purchase \_\_\_\_\_

# CONTENTS

## Before Operating

Precautions .....	Inside Front Cover
Important Safety Instructions .....	2
Installation and Grounding Instructions .....	3
Safety Precautions .....	4
Cookware and Utensil Guide .....	5
Feature Diagram .....	6
Control Panel .....	6

## Operation

Clock Setting .....	7
Quick Min Function .....	7
To Reheat using Power & Time Setting .....	7
Auto Reheat .....	10
To Defrost using Power & Time Setting .....	7
Inverter Turbo Defrost .....	8 - 9
To Cook using Power & Time Setting .....	7
Inverter Auto Cooking .....	10 - 11
Popcorn Function .....	8
Timer Setting (Kitchen Timer / Stand Time / Delay Start) .....	12
Microwave Shortcuts .....	13
Food Characteristics .....	14
Cooking Techniques .....	14-15
Quick Guide to Operation .....	Back Cover

## Maintenance

Technical Specifications .....	Inside Front Cover
To order Accessories, Books, etc. ....	16
Care of Your Microwave Oven .....	16
Before Requesting Service .....	17
Warranty & Service .....	18

## Manual de instrucciones (Spanish Operating Instructions)

Precauciones .....	19
Instrucciones de Seguridad .....	19 - 20
Instrucciones para Conexión a Tierra .....	20
Instrucciones de Instalación .....	21
Sugerencias Útiles .....	22
Panel de Control .....	23
Sugerencias .....	23
Gráfico de cocción automática .....	24
Guía Rápida de Operación .....	25

# IMPORTANT SAFETY INSTRUCTIONS

Your microwave oven is a cooking device and you should use as much care as you use with a stove or any other cooking device. When using this electric appliance, basic safety precautions should be followed, including the following:

**WARNING**—To reduce the risk of burns, electric shock, fire, injury to persons, or exposure to excessive microwave energy:



1. Read all instructions before using the appliance.
2. Read and follow the specific **“PRECAUTIONS TO AVOID POSSIBLE EXPOSURE TO EXCESSIVE MICROWAVE ENERGY,”** found on the inside front cover.
3. This appliance must be grounded. Connect only to properly grounded outlet. See **“GROUNDING INSTRUCTIONS”** found on page 3.
4. Install or locate this appliance only in accordance with the installation instructions found on page 3.
5. Do not cover or block any openings on this appliance.
6. Do not store or use this appliance outdoors.

Do not use this product near water—for example, near a kitchen sink, in a wet basement, or near a swimming pool, and the like.

7. Use this appliance only for its intended use as described in this manual. **DO NOT** use corrosive chemicals, vapors, or non-food products in this appliance. This type of oven is specifically designed to heat or cook. It is not designed for industrial or laboratory use. The use of corrosive chemicals in heating or cleaning will damage the appliance and may result in radiation leaks.
8. When cleaning surfaces of door and oven that come together on closing the door, use only mild, non-abrasive soaps or detergents applied with a sponge or soft cloth.
9. Do not allow children to use this appliance, unless closely supervised by an adult.
10. Do not operate this appliance if it has a damaged cord or plug, if it is not working properly, or if it has been damaged or dropped.
11. Do not immerse cord or plug in water.
12. Keep cord away from heated surfaces.
13. Do not let cord hang over edge of a table or counter.
14. This appliance should be serviced only by qualified service personnel. Contact the nearest authorized servicenter for examination, repair or adjustment.
15. Some products such as whole eggs, narrow neck bottles and sealed containers—for example, closed glass jars—may explode and should not be heated in this oven.

16. To reduce the risk of fire in the oven cavity:
  - (a) Do not overcook food. Carefully attend appliance if paper, plastic, or other combustible materials are placed inside the oven to facilitate cooking.
  - (b) Remove wire twist-ties from paper or plastic bags before placing bag in oven.
  - (c) **If materials inside the oven should ignite, keep oven door closed, turn oven off, and disconnect the power cord, or shut off power at the fuse or circuit breaker panel.**
  - (d) Do not use the cavity for storage purposes. Do not leave paper products, cooking utensils, or food in the cavity when not in use.

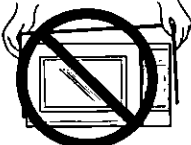
## General Use

1. **DO NOT** tamper with or make any adjustments or repairs to door, Control Panel housing, safety interlock switches or any other part of the oven. **DO NOT** remove outer panel from oven. Repairs should only be done by a qualified service person. 
2. **DO NOT** operate the oven empty. The microwave energy will reflect continuously throughout the oven causing overheating, if food or water is not present to absorb energy. This could damage the oven and result in the risk of a fire. 
3. **DO NOT** dry clothes, newspapers or other materials in oven, or use newspapers or paper bags for cooking. Fire could result.
4. **DO NOT** use recycled paper products unless the paper product is labeled as safe for microwave oven use. Recycled paper products may contain impurities which may cause sparks, and result in fires when used.
5. **DO NOT** hit or strike Control Panel. Damage to controls may occur. Fire could result.
6. **POT HOLDERS** should always be used when removing items from the oven. Heat is transferred from the **HOT** food to the cooking container and from the cooking container to the Glass Tray. The Glass Tray can be very **HOT** after removing the cooking container from the oven.
7. **DO NOT** store flammable materials next to, on top of, or in the oven. These could be fire hazards.

## SAVE THESE INSTRUCTIONS

For proper use of your oven read remaining safety cautions and operating instructions.

# Installation and Grounding Instructions

## Examine Your Oven

Unpack oven, remove all packing material and examine the oven for any damage such as dents, broken door latches or cracks in the door. Notify dealer immediately if oven is damaged. **DO NOT** install if oven is damaged.

## Placement of Oven

- Oven must be placed on a flat, stable surface. For proper operation, the oven must have sufficient air flow. Allow 3-inches (7.6 cm) of space on both sides of the oven and 1-inch (2.5 cm) of space on top of oven.
  - DO NOT** block air vents. If they are blocked during operation, the oven may be overheated and damaged. When using any cloth over the oven, the air intake and exhaust should not be blocked. Also should allow space on back and both sides of oven properly.
  - DO NOT** place oven near a hot, damp surface such as a gas or electric range, or dishwasher
  - DO NOT** operate oven when room humidity is too high.

- This oven was manufactured for household use only.

## Grounding Instructions

**This appliance must be grounded.** In the event of an electrical short circuit, grounding reduces the risk of electric shock by providing an escape wire for the electric current. This appliance is equipped with a cord having a grounding wire with a grounding plug. The plug must be plugged into an outlet that is properly installed and grounded.

## WARNING—Improper use of the grounding plug can result in a risk of electric shock.

Consult a qualified electrician or service person if the grounding instructions are not completely understood or if doubt exists as to whether the appliance is properly grounded. If it is necessary to use an extension cord, use only a three wire extension cord that has a three blade grounding plug, and a three slot receptacle that will accept the plug on the appliance. The marked rating of the extension cord should be equal to or greater than the electrical rating of the appliance.

## Power Supply

- A short power-supply cord is provided to reduce the risks resulting from becoming entangled in or tripping over a longer cord.
- Longer cord sets or extension cords are available and may be used if care is exercised in their use.
- If a long cord or extension cord is used, (1) the marked electrical rating of the cord set or extension cord should be at least as great as the electrical rating of the appliance, (2) the extension cord must be a grounding-type 3-wire cord, and (3) the longer cord should be arranged so that it will not drape over the counter top or tabletop where it can be pulled on by children or tripped over accidentally.

## Wiring Requirements

- The oven must be on a **SEPARATE CIRCUIT**. No other appliance should share the circuit with the microwave oven. If it does, the branch circuit fuse may blow, the circuit breaker may trip, or the food may cook slower than the times recommended in this manual.
- The **VOLTAGE** used must be the same as specified on this microwave oven (120 V, 60 Hz). Using a higher voltage is dangerous and may result in a fire or other incident causing oven damage. Using a lower voltage will cause slow cooking. Panasonic is **NOT** responsible for damage resulting from the use of the oven with other than the specified voltage.
- The oven must be plugged into at least a **20 AMP, 120 VOLT, 60 HZ GROUNDED OUTLET**. Where a standard two-prong outlet is encountered, it is the personal responsibility and obligation of the consumer to have it replaced with a properly grounded three-prong outlet.



## TV / Radio Interference

- Operation of the microwave oven may cause interference to your radio, TV or similar equipment.
- When there is interference, it may be reduced or eliminated by taking the following measures:
  - Clean door and sealing surfaces of the oven. (See Care of Your Microwave Oven)
  - Place the radio, TV, etc. away from the microwave oven as far as possible.
  - Use a properly installed antenna to obtain stronger signal reception.

## Glass Tray

- DO NOT** operate the oven without Roller Ring and Glass Tray in place.
- DO NOT** operate the oven without the Glass Tray fully engaged on the drive hub. Improper cooking or damage to the oven could result. Verify that the Glass Tray is properly engaged and rotating by observing its rotation when you press **Start**.
- Only use the Glass Tray specifically designed for this oven. Do not substitute any other glass tray.
- If the Glass Tray is hot, allow to cool before cleaning or placing in water.
- DO NOT** cook directly on the Glass Tray. Always place food in a microwave-safe dish, or on a rack set in a microwave-safe dish.
- If food or utensil on the Glass Tray touches oven walls, causing the tray to stop moving, the tray will automatically rotate in the opposite direction. This is normal.
- Glass Tray can turn in either direction.

## Roller Ring

- Roller Ring and oven floor should be cleaned frequently to prevent excessive noise.
- Roller Ring must always be used for cooking along with Glass Tray.
- Always replace Roller Ring and Glass Tray in their proper positions.

# Safety Precautions

## Follow These Safety Precautions When Cooking in Your Oven

### IMPORTANT

Proper cooking depends upon the power, the time set and the quantity of food. If you use a smaller portion than recommended and cook at the time for the recommended portion, fire could result.

#### 1) HOME CANNING / DRYING FOODS / SMALL QUANTITIES OF FOODS

- **DO NOT** use your oven for home canning, your oven cannot maintain the food at the proper canning temperature. Improperly canned food may spoil and be dangerous to consume.
- **DO NOT** dry meats, herbs, fruits or vegetables in your oven. Small quantities of food or foods with low moisture content can dry out, scorch or catch on fire if overheated.

#### 2) POPCORN

Popcorn may be popped in a microwave oven corn popper. Microwave popcorn which pops in its own package is also available. Follow popcorn manufacturers' directions and use a brand suitable for the wattage of your microwave oven.

**CAUTION:** When using pre-packaged microwave popcorn, follow recommended package instructions. Check package weight before using the *Popcorn* pad (see *Popcorn Pad* section). Set the oven for the weight of the popcorn package.

If these instructions are not followed, the popcorn may not pop adequately or may ignite and cause a fire. Never leave oven unattended when popping popcorn. Allow the popcorn bag to cool before opening, always open the bag away from your face and body to prevent steam burns.

#### 3) DEEP FAT FRYING

- **DO NOT** attempt to deep fat fry in your microwave oven. Cooking oils may burst into flames and may cause damage to the oven and perhaps result in burns. Microwave utensils may not be able to withstand the temperature of the hot oil, and could shatter or melt.

#### 4) FOODS WITH NONPOROUS SKINS

- Potatoes, apples, whole eggs, egg yolks, whole squash and sausages are examples of foods with nonporous skins. These types of foods must be pierced before microwave cooking to prevent their bursting.
- Use fresh potatoes for baking and cook until just done. Use recommended weights for programmed cooking. Overcooking causes dehydration and may result in a fire.

#### 5) LIQUIDS

- Liquids can become "superheated" in a microwave, and when the container is moved in any way, the **superheated liquids can "explode" out of the container.**
- "Superheated" water is hotter than boiling water, **EVEN THOUGH IT DOES NOT APPEAR TO BUBBLE.** To reduce the possibility of this occurrence:

**Always make sure that liquids are stirred vigorously** before heating to assure that the liquid is mixed with air. **NEVER HEAT LIQUIDS FOR AN EXCESSIVE LENGTH OF TIME.**

#### 6) GLASS TRAY / COOKING UTENSILS / FOIL

- Cooking utensils get hot during microwaving. Heat is transferred from the HOT food to the container and the Glass Tray. Use potholders when removing utensils from the oven or when removing lids or plastic wrap covers from cooking utensils to avoid burns.
- The Glass Tray will get hot during cooking. It should be allowed to cool before handling or before paper products, such as paper plates or microwave popcorn bags, are placed in the oven for microwave cooking.
- When using foil, skewers, warming rack or utensils made of metal in the oven, allow at least 1-inch (2.5 cm) of space between metal material and interior oven walls. If arcing occurs (sparkling), remove metal material (skewers etc.) and/or transfer to a non-metallic container.
- Dishes with metallic trim should **not** be used, as arcing may occur.
- If an entree is heated in a foil tray, maintain at least 1-inch (2.5 cm) spacing from the oven walls.

#### 7) PAPER TOWELS / CLOTHS

- **DO NOT** use paper towels or cloths which contain a synthetic fiber woven into them. The synthetic fiber may cause the towel to ignite. Use paper toweling under supervision.

#### 8) BROWNING DISHES / OVEN COOKING BAGS

- Browning dishes or grills are designed for microwave cooking only. Always follow instructions provided by the manufacturer. **DO NOT** preheat browning dish more than 6 minutes.
- If an oven cooking bag is used for microwave cooking, prepare according to package directions. **DO NOT** use a wire twist-tie to close bag, instead use plastic ties, cotton string or a strip cut from the open end of the bag.

#### 9) THERMOMETERS

- **DO NOT** use a conventional meat thermometer in your oven. Arcing may occur. Microwave-safe thermometers are available for both meat and candy.

#### 10) BABY FORMULA / FOOD

- **DO NOT** heat baby formula or food in the microwave oven. The glass jar or surface of the food may appear to be only warm while the interior can be so hot as to burn the infant's mouth and esophagus.

#### 11) REHEATING PASTRY PRODUCTS

- When reheating pastry products, check temperatures of any fillings before eating. Some foods have fillings which heat faster and can be extremely hot, while the surface remains warm to the touch (ex. Jelly Donuts).

#### 12) GENERAL OVEN USAGE GUIDELINES

- **DO NOT** use the oven for any reason other than the preparation of food.
- **DO NOT** leave oven unattended while in use.

## Cookware and Utensil Guide

ITEM	MICROWAVE	COMMENTS
Aluminum Foil	Yes for Shielding only	Small strips of foil can be molded around thin parts of meat or poultry to prevent overcooking. Arcing can occur if foil is too close to oven wall or if too much foil is used.
Browning Dish	Yes	Browning dishes are designed for microwave cooking only. Check browning dish information for instructions and heating chart. Do not preheat for more than 6 minutes.
Brown paper bags	No	May cause a fire in the oven.
Dinnerware Labeled "Microwave-Safe"	Yes	Check manufacturers' use and care directions for use in microwave heating. Some dinnerware may state on the back of the dish, "Oven-Microwave Safe".
Other Dinnerware	?	Use <b>CONTAINER TEST</b> below.
Disposable polyester Paperboard Dishes	Yes	Some frozen foods are packaged in these dishes. Can be purchased in grocery stores.
Fast Food Carton with Metal Handle	No	Metal handle may cause arcing.
Frozen Dinner Tray Metal	Yes	Frozen dinners may be heated in foil tray, if tray is less than 3/4-in. (2 cm) high. Place foil tray in center of oven. Leave at least 1-in. (2.5 cm) space between foil tray and oven walls. Heat only 1 foil tray in the oven at a time. For containers more than 3/4-inch (2 cm) deep, remove food and place in a similar size microwave-safe container.
Microwave-safe	Yes	
Glass Jars	Yes, use caution	Remove lid. Heat food until just warm, not HOT. Most glass jars are not heat resistant. Do not use for cooking.
Glassware Heat Resistant Oven Glassware & Ceramics	Yes	Ideal for microwave cooking and browning. (See <b>CONTAINER TEST</b> below)
Metal Bakeware	No	Not recommended for use in microwave ovens.
Metal Twist-Ties	No	May cause arcing which could cause a fire in the oven.
Oven Cooking Bag	Yes	Follow manufacturers' directions. Close bag with the nylon tie provided, a strip cut from the end of the bag, or a piece of cotton string. Do not close with metal twist-tie. Make six 1/2-in. (1 cm) slits near the closure.
Paper Plates & Cups	Yes	Use to warm cooked foods, and to cook foods that require short cooking times such as hot dogs.
Paper Towels & Napkins	Yes	Use to warm rolls and sandwiches by microwave.
Parchment Paper	Yes	Use as a cover to prevent spattering. Safe for use in microwave, microwave/convection and conventional ovens.
Plastic Microwave-Safe Cookware Reheat & Storage	Yes, use caution	Should be labeled, "Suitable for Microwave Heating." Check manufacturers' directions for recommended uses. Some microwave-safe plastic dishes are not suitable for cooking foods with high fat or sugar content. The heat from hot food may cause the plastic to warp.
Melamine	No	This material absorbs microwave energy. Dishes get HOT!
Plastic Foam Cups	Yes	Plastic foam will melt if foods reach a high temperature. Use to bring foods to a low serving temperature.
Plastic Wrap	Yes	Use to cover food during cooking to retain moisture and prevent spattering. Should be labeled "Suitable for Microwave Heating". Check package directions.
Straw, Wicker, Wood	Yes	Use only for short term reheating and to bring food to a low serving temperature.
Thermometers Microwave-safe, only	Yes	Use only microwave-safe meat and candy thermometers.
Conventional	No	Not suitable for use in microwave oven, will cause sparks and get hot.
Wax paper	Yes	Use as a cover to prevent spattering and to retain moisture.

### CONTAINER TEST

**TO TEST A CONTAINER FOR SAFE MICROWAVE OVEN USE:** Fill a 1-cup glass measure with water and place it in the microwave oven along with the container to be tested; **heat one (1) minute at P10 (HIGH)**. If the container is microwave oven-safe (transparent to microwave energy), the container should remain comfortably cool and the water should be hot. If the container is hot, it has absorbed some microwave energy and should NOT be used. This test cannot be used for plastic containers.

## Feature Diagram

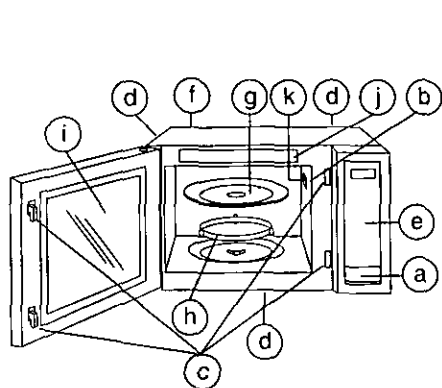

- (a) Door Release Button
- (b) Internal Air Vents
- (c) Door Safety Lock System
- (d) External Air Vents
- (e) Control Panel
- (f) Identification Plate
- (g) Glass Tray
- (h) Roller Ring
- (i) Heat/Vapor Barrier Film  
(do not remove)
- (j) Menu Label
- (k) Cover (do not remove)

## Control Panel

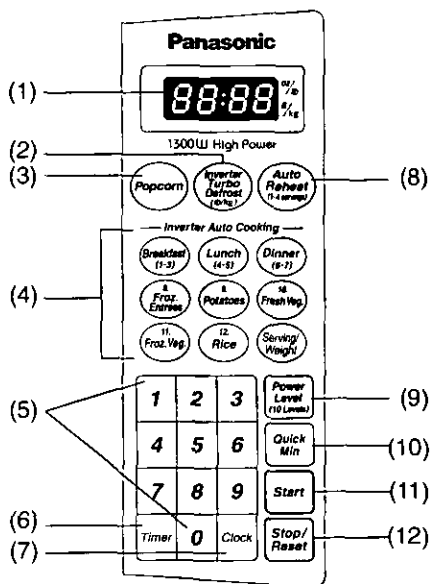

- (1) Display Window
- (2) *Inverter Turbo Defrost* Pad  
(☛page 8)
- (3) *Popcorn* Pad (☛page 8)
- (4) *Inverter Auto Cooking* Pads  
(☛page 10-11)
- (5) Number Pads
- (6) *Timer* Pad (☛page 12)
- (7) *Clock* Pad (☛page 7)
- (8) *Auto Reheat* Pad (☛page 10)
- (9) *Power Level* Pad (☛page 7)
- (10) *Quick Min* Pad (☛page 7)
- (11) *Start* Pad

One tap allows oven to begin functioning. If door is opened or **Stop/Reset** Pad is pressed once during oven operation, **Start** Pad must be pressed again to restart oven.

- (12) **Stop/Reset** Pad  
**Before cooking:** One tap clears your instruction.  
**During cooking:** One tap temporarily stops the cooking process. Another tap cancels all your instructions and time of day or colon appears on the Display Window.

### Beep Sound:

When a pad is pressed correctly, a beep will be heard.



If a pad is pressed and no beep is heard, the unit did not or cannot accept the instruction. The oven will beep twice between programmed stages. At the end of any complete program, the oven will beep 5 times.



## Clock Setting

The oven will operate without setting the clock.

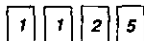
**Example: To set 11:25 a.m. or p.m.**

<b>1.</b>		<ul style="list-style-type: none"> <li>• Press once.</li> <li>▶ Colon flashes.</li> </ul>
<b>2.</b>		<ul style="list-style-type: none"> <li>• Enter time of day using the number pads.</li> <li>▶ Time appears on the Display Window; colon continues flashing.</li> </ul>
<b>3.</b>		<ul style="list-style-type: none"> <li>• Press.</li> <li>▶ Colon stops flashing; time of day is entered.</li> </ul>



**NOTES:**

1. To reset the clock, repeat steps 1- 3.
2. The clock will retain the time of day as long as the oven is plugged in and electricity is supplied.
3. Clock is a 12 hour display.
4. Oven will not operate while colon is flashing.

## Quick Min Function

This feature allows you to set and/or add cooking times easily in multiples of one minute.

### To Set Cooking Time:

<b>1.</b>		<ul style="list-style-type: none"> <li>• Set cooking time (up to 10) Power Level is P10.</li> </ul>
<b>2.</b>		<ul style="list-style-type: none"> <li>• Press <b>Start</b> Pad.</li> <li>▶ Cooking begins and Display Window counts down. At the end of cooking, 5 beeps sound and colon or time of day appears.</li> </ul>



**NOTE:**

1. You can use other power levels, select desired power level before setting cooking time.
2. After setting the time by **Quick Min** Pad, you cannot use **Number Pads**, and vice versa.
3. Press **Quick Min** Pad to add more time during cooking. To verify the additional cooking time, check the **Display Window**.

## Power & Time Setting

How do I program Power and Time?

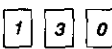
**Example: To cook at P 6 (MEDIUM) Power for 1 minute 30 seconds**

<b>1.</b>		<ul style="list-style-type: none"> <li>• Select <b>Power Level</b> (according to the chart below)</li> </ul>
Press 5 times.		
<b>2.</b>		<ul style="list-style-type: none"> <li>• Set Cooking Time using number pads.</li> </ul>
<b>3.</b>		<ul style="list-style-type: none"> <li>• Press.</li> <li>▶ Cooking will start. The time on the Display Window will count down.</li> </ul>



Press	Power Level
once	P10 (HIGH)
twice	P 9
3 times	P 8
4 times	P 7 (MEDIUM-HIGH)
5 times	P 6 (MEDIUM)
6 times	P 5
7 times	P 4
8 times	P 3 (MEDIUM-LOW)/DEFROST
9 times	P 2
10 times	P 1 (LOW)

**NOTES:**

1. For more than one stage cooking, repeat steps 1 and 2 for each stage of cooking before pressing **Start** Pad. Maximum number of stages for cooking is 5 stages.
2. When selecting P10 (HIGH) power for the first stage, you may begin at step 2.
3. Two beeps will sound between each stage of programming. Five beeps will sound at the end of the entire sequence.
4. When selecting P10 (HIGH) power, the maximum programmable time is 30 minutes. For other power levels, the maximum time is 99 minutes and 99 seconds.
5. For reheating, use P10 (HIGH) for liquids, P7 (MEDIUM-HIGH) for most foods and P6 (MEDIUM) for dense foods.
6. For defrosting, use P3 (MEDIUM-LOW).

## Popcorn Pad

**Example: To heat 3.5 oz. of Popcorn**

<p><b>1.</b></p> <div style="text-align: center;">               Press 5 times         </div>	<ul style="list-style-type: none"> <li>• Set the desired weight of prepackaged microwave popcorn.</li> </ul> <table border="1" style="width: 100%; border-collapse: collapse; margin-top: 5px;"> <thead> <tr> <th style="width: 30%;">Press</th> <th>Weight</th> </tr> </thead> <tbody> <tr> <td>once</td> <td>1.75 oz. (50g)</td> </tr> <tr> <td>twice</td> <td>2.65 oz. (75g)</td> </tr> <tr> <td>3 times</td> <td>2.85 oz. (80g)</td> </tr> <tr> <td>4 times</td> <td>3.0 oz. (85g)</td> </tr> <tr> <td>5 times</td> <td>3.5 oz. (99g)</td> </tr> </tbody> </table>	Press	Weight	once	1.75 oz. (50g)	twice	2.65 oz. (75g)	3 times	2.85 oz. (80g)	4 times	3.0 oz. (85g)	5 times	3.5 oz. (99g)
Press	Weight												
once	1.75 oz. (50g)												
twice	2.65 oz. (75g)												
3 times	2.85 oz. (80g)												
4 times	3.0 oz. (85g)												
5 times	3.5 oz. (99g)												
<p><b>2.</b></p> <div style="text-align: center;">  </div>	<ul style="list-style-type: none"> <li>• Press <b>Start Pad</b>.</li> <li>▶ Cooking time appears in the Display Window and begins to count down.</li> </ul>												

### NOTES ON POPCORN PAD:

1. Use prepackaged **room temperature** microwave popcorn. Read manufacturers' instructions.
2. Place bag in oven according to manufacturers' directions.
3. Pop only one bag at a time.
4. After popping, allow the contents of the bag to cool for a few minutes before opening. Open bag carefully away from face and body because popcorn and steam are extremely hot.
5. Do not reheat unpopped kernels or reuse bag.
6. **NEVER leave oven unattended when popping popcorn.**
7. With the many varieties of microwave popcorn available in the market place, it may be necessary for you to move the popcorn container to the outer edge of the glass tray to obtain the best cooking results.



**Remarks:** When popping multiple bags one right after the other, the cooking times may vary slightly. This does not affect the popcorn results.

**CAUTION:** If pre-packaged popcorn is of a different weight than the recommended weight, do not use the preset popcorn settings. Set power level and time according to the manufacturer's instructions.

## Inverter Turbo Defrost

This feature allows you to defrost meat, poultry and seafood simply by entering the weight.

**Example: To defrost 1.5 pounds of meat.**

<p><b>1.</b></p> <div style="text-align: center;">  </div>	<ul style="list-style-type: none"> <li>• Press.</li> <li>"def" appears briefly in the Display Window.</li> </ul>
<p><b>2.</b></p> <div style="text-align: center;">  </div>	<ul style="list-style-type: none"> <li>• Enter weight of the food using the number pads.</li> </ul>
<p><b>3.</b></p> <div style="text-align: center;">  </div>	<ul style="list-style-type: none"> <li>• Press.</li> <li>▶ Defrosting will start. The time on the Display Window will count down.</li> </ul>

### NOTE:

Time will vary depending on size and wattage of your oven.

### Conversion Chart:

Follow the chart to convert ounces or hundredths of a pound into tenths of a pound. To use Auto Defrost, program the weight of the food in lbs. (1.0) and tenths of a lb. (0.1). If a piece of meat weighs 1.95 lbs. or 1 lb. 14 oz., program 1.9 lbs.

Ounces	Hundredths of a Pound	Tenths of a Pound
0	.01 - .05	0.0
1 - 2	.06 - .15	0.1
3 - 4	.16 - .25	0.2
5	.26 - .35	0.3
6 - 7	.36 - .45	0.4
8	.46 - .55	0.5
9 - 10	.56 - .65	0.6
11 - 12	.66 - .75	0.7
13	.76 - .85	0.8
14 - 15	.86 - .95	0.9

# Defrosting Tips & Techniques

## Before Freezing:

1. Freeze meats, poultry and fish in packages with only 1 or 2 layers of food. Place wax paper between layers.
2. Package in heavy-duty plastic wraps, bags (labeled "For Freezer") or freezer paper.
3. Remove as much air as possible, i.e. create a vacuum.
4. Seal securely, date and label.

## To Defrost:

1. Remove wrapper. This helps moisture to evaporate. Juices from food can get hot and cook the food.
2. Set food on microwave safe roasting rack in an appropriately sized dish.
3. Place roasts fat-side down. Place whole poultry breast-side down.
4. Drain liquids during defrosting.
5. Turn over (invert) items during defrosting.
6. Shield edges and ends if needed. (See **Cooking Techniques**).
7. Select power and minimum time so that items will be under-defrosted.

## After Defrosting:



1. Large items may be icy in the center. Defrosting will complete during **STANDING TIME**.
2. Let stand, covered with plastic wrap, in the refrigerator for time shown in the chart below.
3. See chart below for standing time and rinsing directions.
4. Items which have been layered should be rinsed separately or have a longer stand time.

FOOD	DEFROST TIME at P3 (min./lb.)	DURING DEFROSTING	AFTER DEFROSTING	
			Stand Time	Rinse
<b>Fish and Seafood</b> (up to 3 lbs. (1.4 kg))				
Crabmeat	6	Break apart/Rearrange	5 min.	YES
Fish Steaks	4 to 6	Turn over		
Fish Fillets	4 to 6	Turn over/Rearrange/Shield ends		
Sea Scallops	4 to 6	Break apart/Remove defrosted pieces		
Whole fish	4 to 6	Turn over		
<b>Meat</b>				
Ground Meat	4 to 5	Turn over/Remove defrosted portion/ Shield edges	10 min.	NO
Roasts [2½-4 lbs. (1.1-1.8 kg)]	4 to 8	Turn over/Shield ends and defrosted surface	30 min. in refrig.	
Chops/Steak	6 to 8	Turn over/Rearrange/Shield ends and defrosted surface	5 min.	
Ribs/T-bone	6 to 8	Turn over/Rearrange/Shield ends and defrosted surface		
Stew Meat	4 to 8	Break apart/Rearrange/ Remove defrosted pieces		
Liver (thin sliced)	4 to 6	Drain liquid/Turn over/ Separate pieces		
Bacon (sliced)	4	Turn over		
<b>Poultry</b>				
Chicken, Whole (up to 3 lbs. (1.4 kg))	4 to 6	Turn over/Shield	20 min. in refrig.	YES
Cutlets	4 to 6	Break apart/Turn over/ Remove defrosted Pieces	5 min.	
Pieces	4 to 6	Break apart/Turn over/Shield	10 min.	
Cornish Hens	6 to 8	Turn over/Shield		
Turkey Breast (5-6 lbs. (2.3-2.7 kg))	6	Turn over/Shield		

## Auto Reheat



This feature allows you to reheat 1 to 4 servings of precooked room temperature and refrigerator temperature foods without setting power and time.

**Example: To reheat 2 cups of soup**

<p>1.  Press twice.</p>	<ul style="list-style-type: none"> <li>Press until the desired number of servings appears in the <b>Display Window</b>.</li> </ul>
<p>2. </p>	<ul style="list-style-type: none"> <li>Press.               <ul style="list-style-type: none"> <li>Cooking time appears in the <b>Display Window</b> and begins to count down.</li> </ul> </li> </ul>

## Inverter Auto Cooking

**Example: To cook a 10 oz. Frozen Entree.**

<p>1. </p>	<ul style="list-style-type: none"> <li>Press</li> </ul>
<p>2.  Press twice.</p>	<ul style="list-style-type: none"> <li>Press.               <ul style="list-style-type: none"> <li>Verify Serving/Weight in the <b>Display Window</b>.</li> </ul> </li> </ul>
<p>3. </p>	<ul style="list-style-type: none"> <li>Press.               <ul style="list-style-type: none"> <li>Cooking time appears in the <b>Display Window</b> and begins to count down.</li> </ul> </li> </ul>



Press Auto Reheat pad to indicate number or servings	Average Serving Size	Time
once	4-6 oz.	will vary
twice	8 oz.	depending
three times	12 oz.	on size and
four times	16 oz.	wattage of oven

**NOTES:** For best results, follow these recommendations:

- All foods must be previously cooked.
- Foods should always be covered loosely with plastic wrap, wax paper or casserole lid.
- All foods should have a covered stand time of 3 to 5 minutes.
- DO NOT** reheat bread and pastry products using **Auto Reheat** Use manual power and time instead.
- DO NOT** reheat beverages.
- Times are based in an approximate serving size of 4 oz.
- A plate of food is normally 3-4 servings.

## Child Safety Lock

This feature prevents the electronic operation of the oven until cancelled. It does **not** lock the door.

<p>1.  Press three times.</p>	<ul style="list-style-type: none"> <li>Press               <ul style="list-style-type: none"> <li>"Child" appears in the <b>Display Window</b>.</li> </ul> </li> </ul>
<p>2.  Press three times.</p>	<ul style="list-style-type: none"> <li>Press.               <ul style="list-style-type: none"> <li>"Child" disappears and colon or time of day appears.</li> </ul> </li> </ul>

**NOTES:**

- "Child" continues to be displayed until Child Lock is cancelled.
- Keypads may be pressed but the microwave will not start.

## Inverter Auto Cooking



These foods are tested and pre-timed (based on the power rating of this oven) for the quantity of food listed in the chart below. Locale, power fluctuations and personal tastes are not taken into account. Should you prefer your food cooked differently, use power and time method shown on page 7.

MEAL	FOOD	SERVING / WEIGHT	HINTS
<b>Breakfast</b>	<b>1.Oatmeal</b>	0.5, 1 cup	Place inside a microwave-safe serving bowl with no cover. Follow manufacturers' directions for preparation of quick meal.
	<b>2.Beverages</b>	1, 2 cups	Use a microwave-safe coffee cup. Heated liquids can erupt if not mixed with air. Do not heat liquids in your microwave oven without stirring first.
	<b>3.Bacon</b>	4 slices (3.2-4 oz.) (90-110 g) 6 slices (4.8-5.8 oz.) (135-165 g) 10 slices (8.1-9.5 oz.) (230-270 g) 14 slices (11.6-13 oz.) (330-370 g)	Place slices of bacon on a microwave-safe dish. Cover with paper towel. Times may vary by brand (weight). If bacon is not cooked to your liking, continue to heat by manually adding more time.
<b>Lunch</b>	<b>4.Soup</b>	1, 2 cups	Pour soup into a microwave-safe serving bowl. Cover loosely with lid or vented plastic wrap.
	<b>5.Frozen Pizza</b>	4, 8 oz.	Follow manufacturers' directions for preparation.
<b>Dinner</b>	<b>6.Chicken Pieces</b>	6, 12, 18, 24 oz.	Place skin side up. Cover with vented plastic wrap.
	<b>7.Ground Meat</b>	16, 32 oz.	Break apart in glass bowl or colander. Cover with vented plastic wrap. After 2 beeps, stir. Recover and press <i>Start</i> . Juices should be clear. Drain.
<b>8.Frozen Entrées</b>		8, 10, 20, 32 oz.	Follow manufacturers' directions for covering or removing covers. For best results, do not use frozen foods packaged in foil tray. If additional time is needed, continue to cook manually.
<b>9.Potatoes</b>		1, 2, 3, 4 pieces (6-8 oz. each)	Pierce skin with fork 6 times on top. Place potatoes on a microwave-safe dish. Do not cover. Let stand 5 minutes to complete cooking.
<b>10.Fresh Entrées</b>		4, 8, 12, 16 oz.	All pieces should be the same size. Add a small amount of water and cover loosely with lid or vented plastic wrap.
<b>11.Frozen Vegetables</b>		6, 10, 16 oz.	Follow manufacturers' directions. Do not salt until after cooking. Not suitable for vegetables in butter or sauce.
<b>12.Rice</b>		0.5, 1, 1.5 cups	Place rice with hot water in a microwave-safe casserole dish. Let stand 5 to 10 minutes before serving.

## Timer Setting





This feature allows you to program a Standing Time after cooking is completed and to program the oven as a kitchen timer and/or to program a delay start.

### To Use as a Kitchen Timer:





<b>Example: To count 5 minutes</b>	
1. 	• Press.
2. 	• Set desired amount of time using number pads. (up to 99 minutes and 99 seconds).
3. 	• Press. ▶ Time will count down without oven operating.

### To Set Stand Time:

<b>Example: To stand for 5 mins. after cooking (3 mins. at MEDIUM Power)</b>	
--	--

1.  5 times ↓ 	• Enter the desired cooking program (see page 7 for directions).
2. 	• Press once.
3. 	• Set desired amount of Stand Time using number pads. (up to 99 minutes and 99 seconds)
4. 	• Press. ▶ Cooking will start. After cooking, stand time will count down without oven operating.

### To Set Delay Start:

<b>Example: To start cooking 5 minutes later. (3 mins. at MEDIUM Power).</b>	
1. 	• Press once.
2. 	• Enter desired amount of delayed time using number pads. (up to 99 minutes and 99 seconds)
3.  5 times ↓ 	• Enter the desired cooking program (see page 7 for directions).
4. 	• Press. ▶ Delayed time will count down. Then cooking will start.

#### NOTES:

1. If oven door is opened during Stand Time or Kitchen Timer, the time on the screen will continue to count down.
2. Stand time and Delay time cannot be programmed before any Auto Control Function. This is to prevent the starting temperature of food from rising before defrosting or cooking begins. A change in starting temperature could cause inaccurate results.

## Microwave Shortcuts

FOOD	POWER	TIME (in mins.)	DIRECTIONS
To separate <b>Bacon</b> , 1 pound (450 g)	P10(High)	30 sec.	Remove wrapper and place in microwave safe dish. After heating, use a plastic spatula to separate slices.
To soften <b>Brown Sugar</b> 1 cup (250 mL)	P10(High)	20 - 30 sec.	Place brown sugar in microwave safe dish with a slice of bread. Cover with plastic wrap.
To soften <b>Butter</b> , 1 stick, 1/4 pound (110 g)	P3(MED-LOW)	1	Remove wrapper and place butter in a microwave safe dish.
To melt <b>Butter</b> , 1 stick, 1/4 pound (110 g)	P6(MEDIUM)	1 1/2 - 2	Remove wrapper and place butter in a microwave safe dish covered with plastic wrap.
To melt <b>Chocolate</b> , 1 square, 1 oz. (28 g)	P10(High)	1 - 1 1/2	Remove wrapper and place chocolate in a microwave safe dish. Stir before adding more time. (Stir until completely melted.) <i>Note: Chocolate holds its shape even when softened.</i>
To melt <b>Chocolate</b> , 1/2 cup (125 mL) chips	P10(High)	1 - 1 1/2	
To toast <b>Coconut</b> , 1/2 cup (125 mL)	P10(High)	1	Place in a microwave safe dish. Stir every 30 seconds.
To soften <b>Cream Cheese</b> , 8 oz. (250 g)	P3(MED-LOW)	1 - 2	Remove wrapper and place in a microwave safe bowl.
To brown <b>Ground Beef</b> , 1 pound (450 g)	P10(High)	4 - 5	Crumble into a microwave safe colander set into another dish. Stir twice. Drain grease.
To steam <b>Hand Towels</b> - 4	P10(High)	20 - 30 sec.	Soak in water, then wring out excess. Place on a microwave safe dish. Heat. Present immediately.
To soften <b>Ice Cream</b> , 1/2 gallon (2 L)	P3(MED-LOW)	1 - 1 1/2	Check often to prevent melting.
Cup of liquid <b>boiling water, broth, etc.</b> 1 cup, 8 oz. (250 mL) 2 cups, 16 oz. (500 mL)	P10(High)	2 1/2 - 3 4	Heated liquids can erupt if not stirred. Do not heat liquids in microwave oven without stirring before and after heating.
to heat <b>milk</b> 1 cup, 8 oz. (250 mL) 2 cups, 16 oz. (500 mL)	P7(MED- HIGH)	2 - 3 4 - 5	
To roast <b>Nuts</b> , 1 1/2 cups (375 mL)	P10(High)	4 - 5	Spread nuts into a 9-inch (230 mm) microwave safe pie plate. Stir occasionally.
To toast <b>Sesame Seeds</b> , 1/4 cup (50 mL)	P10(High)	3 - 5	Place in a small microwave safe bowl. Stir twice.
To skin <b>Tomatoes</b> (one at a time)	P10(High)	30 sec.	Place tomato into a microwave safe bowl containing boiling water. Rinse and peel. Repeat for each tomato.
To remove <b>Cooking Odors</b>	P10(High)	5	Combine 1 to 1 1/2 cups (250 - 375 mL) water with the juice and peel of one lemon in a small microwave safe bowl. After heating, wipe interior of oven with a cloth.

## Food Characteristics

### Bone and Fat

Both bone and fat affect cooking. Bones may cause irregular cooking. Meat next to the tips of bones may overcook while meat positioned under a large bone, such as a ham bone, may be undercooked. Large amounts of fat absorb microwave energy and the meat next to these areas may overcook.

### Density

Porous, airy foods such as breads, cakes or rolls take less time to cook than heavy, dense foods such as potatoes and roasts. When reheating donuts or other foods with different centers be very careful. Certain foods have centers made with sugar, water or fat and these centers attract microwaves (For ex., jelly donuts). When a jelly donut is heated, the jelly can become extremely hot while the exterior remains warm to the touch. This could result in a burn if the food is not allowed to cool properly in the center.

### Quantity

Two potatoes take longer to cook than one potato. As the quantity of the food increases so does the cooking time. When cooking small amounts of food such as one or two potatoes, do not leave oven unattended. The moisture content in the food may decrease and a fire could result.

### Shape

Uniform sizes heat more evenly. The thin end of a drumstick will cook more quickly than the meaty end. To compensate for irregular shapes, place thin parts toward the center of the dish and thick pieces toward the edge.

### Size

Thin pieces cook more quickly than thick pieces.

### Starting Temperature

Foods that are room temperature take less time to cook than if they are chilled or refrigerated or frozen.

## Cooking Techniques

### Piercing

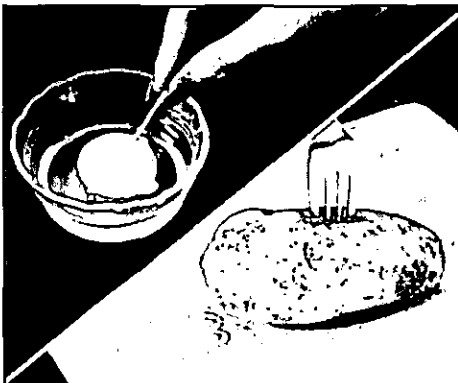

Foods with skins or membranes must be pierced, scored or have a strip of skin peeled before cooking to allow steam to escape. Pierce whole egg yolks and whites, clams, oysters, chicken livers, whole potatoes and whole vegetables. Whole apples or new potatoes should have a 1-inch strip of skin peeled before cooking. Score sausages and frankfurters.

### Browning



Foods will not have the same brown appearance as conventionally cooked foods or these foods which are cooked utilizing a browning feature. Meats and poultry may be coated with browning sauce, Worcestershire sauce, barbecue sauce or shake-on browning sauce. To use, combine browning sauce with melted butter or margarine; brush on before cooking. For quick breads or muffins, brown sugar can be used in the recipe in place of granulated sugar, or the surface can be sprinkled with dark spices before baking.



## Cooking Techniques

### Spacing

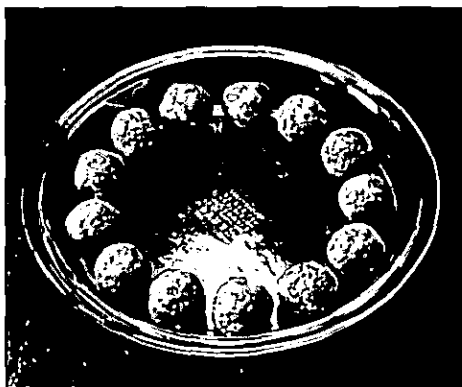

Individual foods, such as baked potatoes, cupcakes and appetizers, will cook more evenly if placed in the oven equal distances apart. When possible, arrange foods in a circular pattern.

### Covering

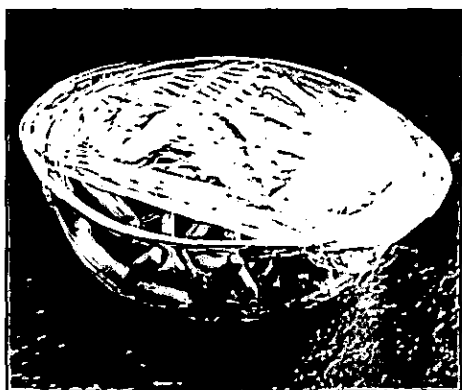

As with conventional cooking, moisture evaporates during microwave cooking. Casserole lids or plastic wrap are used for a tighter seal. When using plastic wrap, vent the plastic wrap by folding back part of the plastic wrap from the edge of the dish to allow steam to escape. Loosen or remove plastic wrap as recipe directs for stand time. When removing plastic wrap covers, as well as any glass lids, be careful to remove them away from you to avoid steam burns. Various degrees of moisture retention are also obtained by using wax paper or paper towels. However, unless specified, a recipe is cooked covered.

## Cooking Techniques

### Shielding

Thin areas of meat and poultry cook more quickly than meaty portions. To prevent overcooking, these thin areas can be shielded with strips of aluminum foil. Wooden toothpicks may be used to hold the foil in place.

### Timing

A range in cooking time is given in each recipe. The time range compensates for the uncontrollable differences in food shapes, starting temperature and regional preferences. Always cook food for the minimum cooking time given in a recipe and check for doneness. If the food is undercooked, continue cooking. It is easier to add time to an undercooked product. Once the food is overcooked, nothing can be done.

### Stirring

Stirring is usually necessary during microwave cooking. We have noted when stirring is helpful, using the words once, twice, frequently or occasionally to describe the amount of stirring necessary. Always bring the cooked outside edges toward the center and the less cooked center portions toward the outside of the dish.

### Rearranging

Rearrange small items such as chicken pieces, shrimp, hamburger patties or pork chops. Rearrange pieces from the edge to the center and pieces from the center to the edge of the dish.

### Turning

It is not possible to stir some foods to redistribute the heat. At times, microwave energy will concentrate in one area of a food. To help insure even cooking, these foods need to be turned. Turn over large foods, such as roasts or turkeys, halfway through cooking.

### Stand Time

Most foods will continue to cook by conduction after the microwave oven is turned off. In meat cookery, the internal temperature will rise 5°F to 15°F (3°C to 8°C), if allowed to stand, tented with foil, for 10 to 15 minutes. Casseroles and vegetables need a shorter amount of standing time, but this standing time is necessary to allow foods to complete cooking to the center without overcooking on the edges.

### Testing Doneness

The same tests for doneness used in conventional cooking may be used for microwave cooking. Meat is done when fork-tender or splits at fibers. Chicken is done when juices are clear yellow and drumstick moves freely. Fish is done when it flakes and is opaque. Cake is done when a toothpick or cake tester is inserted and comes out clean. Candy is done when it reaches the proper temperature for each stage of crystallization.

## Care of Your Microwave Oven

### BEFORE CLEANING:

Unplug at socket of the oven. If impossible, leave oven door open to prevent oven from accidentally turning on.

### AFTER CLEANING:

Be sure to replace the Roller Ring and Glass Tray in the proper position and press **Stop/Reset** Pad to clear the screen.

#### Menu Label:

Do not remove Wipe with a damp cloth.

#### Glass Tray:

Remove and wash in warm soapy water or in a dishwasher.

#### Outside oven surfaces.

Clean with a damp cloth. To prevent damage to the operating parts inside the oven, water should not be allowed to seep into ventilation openings.

#### Inside of the oven:

Wipe with a damp cloth. Mild detergent may be used if the oven gets very dirty. The use of harsh detergent or abrasives is not recommended.

#### Control Panel:

\* Covered with a removable protective film to prevent scratches during shipping. Small bubbles may appear under this film. (Hint - To remove film, apply masking or clear tape to an exposed corner and pull gently.)  
\* If the Control Panel becomes wet, clean it with a soft dry cloth. Do not use harsh detergents or abrasives on the Control Panel.

#### Oven Door:

Wipe with a soft cloth when steam accumulates inside or around the outside of the oven door. During cooking, especially under high humidity conditions, steam is given off from the food. (Some steam will condense on cooler surfaces, such as the oven door. This is normal.) Inside surface is covered with a heat and vapour barrier film. Do not remove.

#### Roller Ring and oven cavity floor:

Wipe the bottom surface of the oven with mild detergent water or window cleaner and dry. Roller Ring may be washed in mild soapy water or dishwasher. These areas should be kept clean to avoid excessive noise.

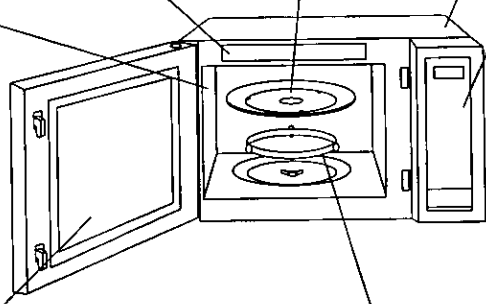

## ORDER FORM

For more information regarding microwave cooking, order our **COOKING GUIDE** (68 pages of recipes & charts).

### DESCRIPTION

Instruction / Operating Manual (this book)  
COOKING GUIDE  
Glass Tray  
Roller Ring Assembly

### PART NUMBER

F00034W31AP  
B000B8250AP  
A06014M00AP      S950  
B06014W00AP      S750  
B290D4M00AP      S950  
B290D9330AP      S750

For pricing quotes, call or write the Parts & Literature Department at the phone or address listed below. Please have your credit card information readily available.

*Shipping & handling are not included. Price & availability subject to change. Sorry, no COD's.*

PANASONIC SERVICES COMPANY  
20421 84th Avenue South  
Kent, WA 98032

(800) 833-9626 - Phone  
(800) 237-9080 - FAX

You can purchase parts, accessories or locate your nearest servicer by visiting our Web Site:

Web Site: <http://www.Panasonic.com>

## Before Requesting Service

### All these things are normal:

The oven causes interference with my TV.

Some radio and TV interference might occur when you cook with the microwave oven. This interference is similar to the interference caused by small appliances such as mixers, vacuums, blow dryers, etc. It does not indicate a problem with your oven.

Steam accumulates on the oven door and warm air comes from the oven vents.

During cooking, steam and warm air are given off from the food. Most of the steam and warm air are removed from the oven by the air which circulates in the oven cavity. However, some steam will condense on cooler surfaces such as the oven door. This is normal.

I accidentally ran my microwave oven without any food in it.

Running the oven empty for a short time will not damage the oven. However, we do not recommend operating the microwave oven without any food in it.

#### PROBLEM

#### POSSIBLE CAUSE

#### REMEDY

Oven will not turn on.



The oven is not plugged in securely.

Remove plug from outlet, wait 10 seconds and reinsert.

Circuit breaker or fuse is tripped or blown.

Reset circuit breaker or replace fuse.

There is a problem with the outlet.

Plug another appliance into the outlet to check if it is working.

Oven will not start cooking.



The door is not closed completely.

Close the oven door securely.

**Start** Pad was not pressed after programming.

Press **Start** Pad.

Another program is already entered into the oven.

Press **Stop/Reset** Pad to cancel the previous program and enter new program.

The program is not correct.

Program again according to the Operating Instructions.

**Stop/Reset** Pad has been pressed accidentally.

Program oven again.

The Glass Tray wobbles.



The Glass Tray is not positioned properly on the Roller Ring or there is food under the Roller Ring.

Take out Glass Tray and Roller Ring. Wipe with a damp cloth and reset Roller Ring and Glass Tray properly.

When the oven is operating, there is noise coming from the glass tray.



The Roller Ring and oven bottom are dirty.

Clean these parts according to **Care of Your Microwave Oven**.

The word "Child" appears in the **Display Window**.



The CHILD LOCK was activated by pressing **Start** pad 3 times.

Deactivate LOCK by pressing **Stop/Reset** pad 3 times.

## Warranty & Service

### PANASONIC MICROWAVE OVEN LIMITED WARRANTY

Panasonic Consumer Electronics Company or Panasonic Sales Company (collectively referred to as "the warrantor") will repair this product with new or refurbished parts in exchange for defective parts, free of charge, in the USA or Puerto Rico from the date of original purchase in the event of a defect in materials or workmanship as follows (all time periods start from the date of original purchase):

**Parts** - one (1) year (except magnetron).

**Magnetron Tube** - five (5) years.

**Labor** - one (1) year on all parts (including, without limitations, magnetron tube). After the labor warranty has expired, the purchaser pays for all labor charges for removal and installation of parts (including, without limitation, magnetron tube).

Carry-in or mail-in service in the USA or Puerto Rico can be obtained during the warranty period by contacting a Panasonic Services Company (PASC) Factory Servicenter listed in the Servicenter Directory. Or call, toll free, 1-800-211-PANA to locate a PASC authorized Servicenter. Carry-in or mail-in service in Puerto Rico can be obtained during the warranty period by calling the Panasonic Sales Company telephone number listed in the Servicenter Directory.

This warranty is extended only to the original purchaser. A purchase receipt or other proof of date of original purchase will be required before warranty service is rendered.

This warranty only covers failures due to defects in materials or workmanship which occur during normal use and does not cover glass, plastic parts, temperature probes (if included), and the exterior and interior finish. The warranty does not cover damages which occur in shipment, or failures which are caused by products not supplied by the warrantor, or failures

which result from accident, misuse, abuse, neglect, mishandling, misapplication, faulty installation, improper set-up adjustments, operation and/or maintenance, or alteration, modification, power line surge, improper voltage supply, lightning damage, or commercial use such as hotel, office, restaurant or other business or rental use of the product, or service by anyone other than a PASC Factory Servicenter or a PASC authorized Servicenter, or damage that is attributable to acts of God.

### LIMITS AND EXCLUSIONS

There are no express warranties except as listed above.

THE WARRANTOR SHALL NOT BE LIABLE FOR INCIDENTAL OR CONSEQUENTIAL DAMAGES RESULTING FROM THE USE OF THIS PRODUCT, OR ARISING OUT OF ANY BREACH OF THIS WARRANTY. ALL EXPRESS AND IMPLIED WARRANTIES, INCLUDING THE WARRANTIES OF MERCHANTABILITY, AND FITNESS FOR A PARTICULAR PURPOSE, ARE LIMITED TO THE APPLICABLE WARRANTY PERIOD SET FORTH ABOVE.

Some states do not allow the exclusion or limitation of incidental or consequential damages, or limitations on how long an implied warranty lasts, so the above exclusions or limitations may not apply to you.

This warranty gives you specific legal rights and you may also have other rights which vary from state to state. If a problem with this product develops during or after the warranty period, you may contact your dealer or Servicenter. If the problem is not handled to your satisfaction, then write to the Customer Satisfaction Center.

### Factory Servicenters Locations

#### CALIFORNIA

6550 Katella Ave.  
Cypress, CA 90630

800 Dubuque Ave.  
S. San Francisco,  
CA 94080

3878 Ruffin Rd., Suite A  
San Diego, CA 92123

#### COLORADO

1640 South Abilene St.  
Suite D  
Aurora, CO 80012

#### FLORIDA

3700 North 29th Ave.  
Suite 102  
Hollywood, FL 33020

#### GEORGIA

8655 Roswell Road  
Suite 100  
Atlanta, GA 30350

#### ILLINOIS

9060 Golf Road  
Niles, IL 60714

1703 N. Randall Road  
Elgin, IL 60123  
(Pick up/Drop off only)

#### MARYLAND

62 Mountain Road  
Glen Burnie, MD 21061

#### MASSACHUSETTS

60 Glacier Drive, Suite G  
Westwood, MA 02090

#### MINNESOTA

7850-12th Ave. South  
Airport Business Center  
Bloomington, MN 55425

#### OHIO

2236 Waycross Road  
Civic Center Plaza  
Forest Park, OH 45240

#### PENNSYLVANIA

2221 Cabot Blvd. West  
Suite B  
Langhorne, PA 19047

#### TEXAS

13615 Welch Road  
Suite 101  
Farmers Branch,  
TX 75244

#### WASHINGTON

20425-84th Ave. So.  
Kent, WA 98032

#### HAWAII

99-859 Iwaiwa Street  
Aiea, Hawaii 96701  
Phone (808) 488-1996  
Fax (808) 486-4639

**Puerto Rico:** Matsushita Electric of Puerto Rico, Inc. Panasonic Sales Company / Factory Servicenter  
Ave. 65 de Infanteria, Km. 9.5, San Gabriel Industrial Park, Carolina, Puerto Rico 00985  
Phone (787) 750-4300 Fax (787) 768-2910

# INSTRUCCIONES DE SEGURIDAD

Su horno de microondas es un artículo para cocinar y usted debe usarlo con tanto cuidado como usa una estufa o cualquier otro artículo para cocinar.

Cuando utilice este aparato eléctrico, se deben seguir precauciones básicas de seguridad, incluyen- do las siguientes:

**PRECAUCION**—To reduce the risk of burns, electric shock, fire, injury to persons, or exposure to excessive microwave energy:

1. Lea todas las instrucciones antes de usar el aparato.
2. Lea y siga las "PRECAUCIONES PARA EVITAR POSIBLE EXPOSICION EXCESIVA A ENERGIA DE MICROONDAS" específicas, que se encuentran abajo.
3. Este aparato debe ser conectado a tierra. Conecte solamente a la toma eléctrica debidamente conectada a tierra. Vea las "INSTRUCCIONES PARA CONEXIÓN A TIERRA" que se encuentran en la página 20.
4. Instale o ubique este aparato solamente de acuerdo con las instrucciones de instalación que se encuentran en la página 21.
5. No cubra ni tape ninguna de las rendijas de este aparato.
6. No almacene o use este aparato en exteriores. No use este aparato cerca del agua - por ejemplo, cerca del fregadero de la cocina, en una base mojada, o cerca de una alberca, y similares.
7. Use este aparato sólo para los fines para los que fué hecho, tal como se describen en este manual. No use químicos o vapores corrosivos en este aparato. Este tipo de horno está específicamente diseñado para calentar o cocinar alimentos. No fué diseñado para uso industrial o de laboratorio.
8. Cuando limpie las superficies de la puerta y el horno que vienen juntas al cerrar la puerta, use solamente jabones no abrasivos o detergentes suaves aplicados con una esponja o con tela suave.
9. No permita a los niños usar este aparato, a

menos que sean supervisados muy de cerca por un adulto.

10. No use este aparato si tiene dañado el cordón o la clavija, si no está trabajando adecuadamente, o si ha sido dañado o se ha dejado caer.
11. No sumergir en agua el cable o la clavija.
12. Mantenga el cordón lejos de superficies calientes.
13. No deje el cordón colgando en el borde de la mesa o mostrador.
14. Este aparato debe recibir mantenimiento sólo de personal calificado. Contacte las instalaciones de servicio autorizadas más cercanas para revisión, reparación o ajuste.
15. Algunos productos, tales como los huevos completos y contenedores sellados - por ejemplo frascos de vidrio cerrados - pueden explotar y no deben ser calentados en este horno.
16. Para reducir el riesgo de incendio en la cavidad del horno:
  - (a) No sobrecoccine los alimentos. Preste atención cuidadosamente al aparato. El papel, plástico u otros materiales combustibles son colocados dentro del horno para facilitar la cocción pero si no se utilizan adecuadamente esto puede producir incendio en su horno.
  - (b) Quite los sujetadores de alambre de las bolsas de papel o plástico antes de colocar la bolsa en el horno.
  - (c) Quite los sujetadores de alambre de las bolsas de papel o plástico antes de colocar la bolsa en el horno.
  - (d) No use la cavidad con propósitos de almacenaje. No deje productos de papel, utensillos de cocina o alimentos en la cavidad cuando no esté en uso.

## Guarde estas instrucciones

### PRECAUCIONES PARA EVITAR POSIBLE EXPOSICION EXCESIVA A ENERGIA DE MICROONDAS

- (a) No intente hacer funcionar este horno con la puerta abierta ya que esto puede resultar peligroso. Es importante no anular o biogear los mecanismos de seguridad.
- (b) No coloque ningún objeto entre el panel frontal del horno y la puerta, ni permita que se acumule basura o residuos de limpiadores en las superficies de sellado.
- (c) No haga funcionar el horno si está dañado, es importante que la puerta del horno abra y cierre apropiadamente:
  - (1) la puerta (combada)
  - (2) bisagras y seguro de la puerta (rotos o sueltos)
  - (3) sellos de las puertas y superficies de sellado
- (d) El horno o deberá ser ajustado o reparado por ninguna persona, excepto el personal de servicio debidamente calificado.

# INSTRUCCIONES DE SEGURIDAD

## Uso General

- NO** altere o haga ningún ajuste o reparación a la puerta, al alojamiento del panel de control, interruptores entrecruzados de seguridad o a cualquier otra parte del horno. **NO** quite el panel exterior del horno. Las reparaciones deben ser hechas solamente por personal de servicio calificado.
- NO** opere el horno vacío. La energía de microondas se reflejará continuamente a través del horno si los alimentos o agua no están presentes para absorber energía. Esto puede dañar el horno y resultar en peligro de incendio.
- NO** utilice este horno para calentar químicos o cualquier otros productos no alimenticios. **NO** limpie este horno con cualquier producto etiquetado con contenido químico corrosivo. El calentamiento de químicos corrosivos en este horno puede causar fugas de radiación.
- NO** seque telas, periódicos u otros materiales en el horno. Pueden incendiarse.
- NO** use productos de papel reciclado, ya que pueden contener impurezas que pueden causar chispas y/o incendios cuando se usen.
- NO** use periódicos o bolsas de papel para cocinar. Puede causar un incendio.
- NO** pegue, **NO** golpee el panel de control. Pueden causarse daños a los controles. Puede causar un incendio.
- Las manoplas para tomar cosas calientes siempre deben ser utilizados cuando se retiren cosas de el horno. El calor se transfiere de los alimentos calientes a los contenedores para cocinar y de los contenedores a la Bandeja de Cristal. La Bandeja de Cristal puede estar muy caliente después de sacar los contenedores para cocinar del horno.
- NO** almacene materiales inflamables cerca, arriba, o dentro del horno. Pueden ser riesgos de incendio.

## INSTRUCCIONES PARA CONEXION A TIERRA

Este aparato debe ser conectado a tierra. En el caso de un corto circuito, la conexión a tierra reduce el riesgo de una descarga eléctrica proporcionando una línea de escape para la corriente eléctrica. Este aparato está equipado con un cable y clavija para conexión a tierra. La clavija debe ser conectada en un receptor que esté instalado adecuadamente y conectado a tierra.

**PRECAUCIÓN** - El uso inapropiado de la clavija para conexión a tierra puede resultar en riesgo de descarga eléctrica.

Consulte a un electricista o a personal de servicio calificados, si las instrucciones para conectar a tierra no son completamente comprendidas o si existe duda de que el aparato está correctamente conectado a tierra. Si es necesario usar un cable de extensión, use solamente cable de extensión de tres hilos que tenga una clavija de tres entradas para conectar a tierra, y un receptor de tres ranuras que acepte la clavija del aparato. El calibre marcado en el cable de extensión debe ser igual o mayor al calibre eléctrico del aparato.

## Suministro Eléctrico

- Se provee un cable de suministro eléctrico corto para reducir los riesgos resultantes de enredarse o tropezarse con un cable más largo.
- Juegos de cable más largos o extensiones están disponibles y pueden utilizarse si se usan con cuidado.
- Si se usa un cable más largo o extensión, (1) el calibre eléctrico marcado en el juego de cordón o extensión debe ser al menos tan grande como el calibre eléctrico del aparato, (2) el cable de extensión debe ser de tres hilos del tipo de conexión a tierra, y (3) el cordón más largo debe ser arreglado de tal forma que no caiga sobre la cubierta del mostrador o de la mesa donde pueda ser jalado por niños o tropezarse accidentalmente.

# INSTRUCCIONES DE INSTALACION

## Examine Su Horno

Desempaque el horno, quite todo el material de empaque y examine que su horno no tenga ningún daño, tales como abolladuras, seguros de la puerta rotos o resquebrajaduras en la puerta. Notifique inmediatamente a su distribuidor si el horno está dañado.

## Ubicación del Horno

1. El horno debe ser colocado en una superficie plana y estable. Para su operación apropiada, el horno debe tener suficiente corriente de aire. Deje 8 cm de espacio de ambos lados del horno y 2.5 cm de espacio en la parte superior del horno.
  - a. **NO** bloquee la ventilación del aire. Si es bloqueada la ventilación del aire durante la operación, el horno puede sobrecalentarse y quemarse. Cuando use algún trapo, franela o funda para cubrir el horno, las tomas y salidas del aire no deberán ser bloqueadas. También debe tener un espacio apropiado para la parte trasera y los costados.
  - b. **NO** coloque el horno cerca de una superficie húmeda caliente, tal como un registro de gas o eléctrico.
  - c. **NO** opere el horno cuando la humedad del cuarto sea muy alta.
2. Este horno ha sido fabricado para uso en el hogar solamente.

## Interferencia de Radio

1. La operación de su horno de microondas puede causar interferencia en su radio, TV o equipo similar.
2. Cuando hay interferencia, se puede reducir o eliminar tomando las siguientes medidas:
  - a. Limpie la puerta y las superficies selladoras del horno.
  - b. Ponga el radio, TV, etc. lo más lejos posible del horno de microondas.
  - c. Use una antena instalada adecuadamente para obtener una recepción de señal más fuerte.

## Requerimientos de cableado

1. El horno debe estar en un circuito separado. Ningún otro aparato debe compartir el circuito con el horno. Si lo hace el fusible del circuito puede estallar, el bloqueador del circuito trabarse o la comida cocinarse más lento que en los tiempos recomendados en este manual.
2. El voltaje usado debe ser el mismo al especificado en el horno de microondas (120 V.). Usar un voltaje más alto es peligroso y puede resultar en fuego u otro accidente causando daño al horno. Usar un bajo voltaje dará como resultado un cocinado más lento. Panasonic no se hace responsable por daños resultantes del uso del horno con otros voltajes que no sea el especificado.
3. El horno debe ser conectado en un enchufe a tierra de al menos 20 amp 120 volt, 60 Hz. Donde se encuentre un enchufe estándar de 2 entradas es responsabilidad y obligación del consumidor reemplazarlo por un enchufe a tierra de 3 entradas.



## Especificaciones Técnicas

	NN-S950	NN-S750
Potencia Fuente de Poder:	11,5 A, 1 320 W	11,5 A, 1 320 W
Potencia de Salida:*	1 300 W	1 300 W
Dimensiones Exteriores (Alto x Ancho x Fondo):	356 x 606 x 497mm	304 x 555 x 497mm
Dimensiones Cavidad del Horno (Alto x Ancho x Fondo):	278 x 469 x 470mm	228 x 418 x 470mm
Frecuencia:	2 450 MHz	2 450 MHz
Peso Sin Embalaje:	Approx. 16,6 kg	Approx. 14,3 kg

\*Determinado de acuerdo a procedimientos contemplados en la norma IEC 705-88.

Las especificaciones están sujetas a cambios sin previo aviso.

## Sugerencias Útiles

### Siga Esta Precauciones de Seguridad Cuando Cocine en Su Horno

#### IMPORTANTE

La cocción adecuada depende del tiempo designado y del peso de los alimentos. Si usa una porción menor de la recomendada y cocina por el tiempo para la porción recomendada, puede resultar un incendio. Si ocurre un incendio, ponga el horno en posición de apagado y manténgalo cerrado. Desconecte la energía eléctrica o desconecte la caja de fusibles o el panel de control.

#### 1) ENLATADO CASERO/ALIMENTOS DESHIDRATADOS/PEQUEÑAS CANTIDADES DE ALIMENTOS

- No use su horno para el enlatado casero o para calentar cualquier frasco cerrado. La presión aumentará y el frasco puede explotar. Su horno no puede mantener los alimentos a la temperatura apropiada de enlatado.
- Pequeñas cantidades de alimento o alimentos con bajo contenido de humedad se pueden secar, quemar o incendiarse.
- No seque alimentos, hierbas, frutas o vegetales en su horno.

#### 2) PALOMITAS DE MAÍZ

Las palomitas de maíz deben prepararse en un recipiente para palomitas de maíz adecuado para horno de microondas. Palomitas de maíz para horno de microondas que se preparan en su propio paquete también están disponibles. Siga las instrucciones del fabricante de palomitas de maíz y use una marca adecuada para la potencia de su horno de microondas. Nunca deje desatendido el horno cuando prepare palomitas de maíz.

#### PRECAUCIÓN

Cuando use palomitas de maíz para microondas previamente empacado siga las instrucciones recomendadas en el paquete. Revise el peso del paquete antes de usar la tecla de palomitas de maíz. Prepare el horno para el peso del paquete de palomitas de maíz. Si no se siguen estas instrucciones, las palomitas de maíz pueden no reventar adecuadamente o pueden encenderse y causar un incendio.

#### 3) FREIR CON MUCHA GRASA

- No trate de freír con mucha grasa en su horno de microondas. Cocinar aceites puede estallar en flamas y puede causar daño al horno y quizá acabar en quemaduras. Los utensilios de microondas pueden no ser útiles para soportar la temperatura del aceite caliente, y podrían romperse.

#### 4) HUEVOS

- No caliente huevos en su cascara en el horno de microondas. La presión subirá y el huevo explotará.

#### 5) ALIMENTOS CON PIELES NO POROSAS

- Papas, manzanas, yemas de huevo, calabazas completas y salchichas son ejemplos de alimentos con pieles no porosas. Estos tipos de alimentos deben ser perforados antes de cocinarlos en Microondas para evitar que Estallen.

- Use papas frescas para hornear y cocínelas hasta que estén listas. Cocinar demasiado causa deshidratación y puede producir un incendio. Use los pesos recomendados o puede ocurrir un incendio.

#### 6) LIQUIDOS

- Los líquidos pueden "sobrecalentarse" en el microondas y, cuando el recipiente se desplaza en un sentido, los líquidos sobrecalentados pueden "desbordarse" fuera del recipiente. El agua "sobrecalentada" es más caliente que el agua hervida, AUNQUE NO HAGA BURBUJAS. Para reducir la posibilidad de que esto ocurra, siempre debe agitar con fuerza los líquidos antes de calentarlos para que el líquido se mezcle con aire. NO CALIENTE NUNCA LOS LIQUIDOS DURANTE UN TIEMPO PROLONGADO.

#### 7) BANDEJA DE CRISTAL/UTENSILIOS DE COCINA/PAPEL ALUMINIO

- Los utensilios para cocinar se calientan durante la cocción en microondas. Use soportes para lo caliente, cuando saque los utensilios del horno o cuando quite tapas o cubiertas de envoltura de plástico de los utensilios de cocina, para evitar quemaduras.
- La bandeja de cristal se calentará durante la cocción. Debe permitirse que se enfríe antes de manejarla o antes de colocar productos de papel, tales como platos de papel o bolsas de palomitas de maíz para microondas, para cocinar.
- Cuando se use papel aluminio, brochetas, rejillas para calentar o utensilios hechos de metal en el horno, deje por lo menos 2,5 cm de espacio entre el material de metal y las paredes interiores del horno. Si arquea (chispea) quite el material de metal (brochetas etc.) y/o cambíelo a un contenedor no metálico.
- Platos con adornos metálicos no deben ser usados, ya que puede producirse arco eléctrico.

#### 8) TOALLAS DE PAPEL/TELAS

- No use toallas de papel o telas que contengan fibras sintéticas en su tejido. La fibra sintética puede causar que la toalla se incendie.
- No use bolsas de papel o productos de papel recitado en el horno de microondas.

#### 9) BANDEJA DORADOR/BOLSAS PARA COCINAR EN HORNO

- Los bandeja doradora o asados son diseñados para cocinar en microondas solamente. Siempre siga las instrucciones dadas por el fabricante. No precaliente la bandeja doradora mas de 8 min.
- Si se usa una bolsa para cocinar para el microondas, prepare de acuerdo a las instrucciones del paquete. No use sujetadores de alambre para cerrar la bolsa.

#### 10) TERMÓMETROS

- No use termómetros convencionales para alimentos en su horno. Puede producir arco.

#### 11) GUÍA DE USO GENERAL DEL HORNO/PUERTA DEL HORNO

- No use el horno por cualquier razón que no sea la preparación de alimentos.
- No deje sin atención el horno mientras esté en uso.



# Panel de Control

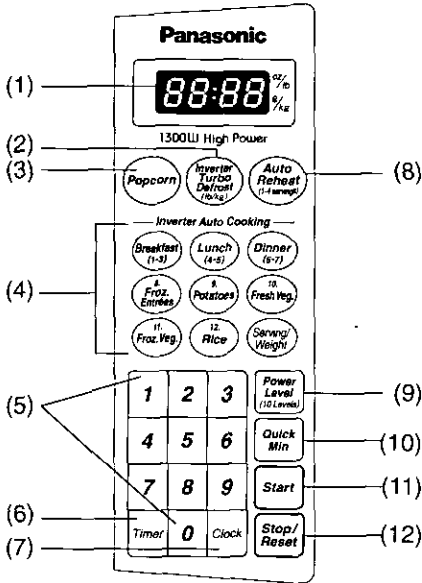

- (1) Pantalla indicadora (Ventana de Visualización)
- (2) Pulsador de descongelamiento Turbo Inverter
- (3) Pulsador de palomitas de maíz
- (4) Pulsadores de auto cocción
- (5) Pulsadores de numéricos
- (6) Pulsador de tiempo
- (7) Pulsador de reloj
- (8) Pulsador de recalentamiento automático
- (9) Pulsador de potencia
- (10) Pulsador de rapido en minutos
- (11) Pulsador Para Comenzar
- (12) Pulsador Para/Cancelar

## Sugerencias

### Nivel de Potencia

Pulse	Nivel de Potencia
1 vez	P10 (Alto)
2 veces	P9
3 veces	P8
4 veces	P7 (Medio-alto)
5 veces	P6 (Medio)
6 veces	P5
7 veces	P4
8 veces	P3 (Medio-bajo)
9 veces	P2
10 veces	P1 (Bajo)

### Pulsador de Palomitas

Pulse	Peso
1 vez	1.75 oz. (50g)
2 veces	2.65 oz. (75g)
3 veces	2.85 oz. (80g)
4 veces	3.0 oz. (85g)
5 veces	3.5 oz. (99g)

#### Notas:

1. Use los paquetes previamente empacados de palomitas de maíz para microondas a temperatura ambiente. Lea las instrucciones del fabricante.
2. Coloque la bolsa en el horno de acuerdo a las instrucciones del fabricante.
3. Coloque solamente una bolsa a la vez.
4. Después de preparadas, abra la bolsa cuidadosamente, las palomitas de maíz y el vapor estarán extremadamente calientes.
5. No vuelva a calentar los granos que no reventaron ni vuelva a usar la bolsa.
6. Nunca deje el horno desatendido cuando prepare palomitas de maíz.
7. Debido a la gran variedad de palomitas de maíz para microondas en el mercado, tal vez sea necesario poner la bolsa en la orilla del plato giratorio para obtener mejores resultados.

#### PRECAUCION:



Si el paquete de palomitas de maíz previamente empacado es de un peso diferente a el recomendado, no use el sistema indicado para palomitas de maíz, o puede ocurrir que no se preparen adecuadamente o un incendio. Siga las instrucciones del fabricante.

## Gráfico de cocción automática

Esta función le permite cocinar la mayor parte de sus alimentos favoritos y algunas recetas nuevas gracias al Nuevo Sistema de Cocción con Inverter.

































Podrá cocinar sin necesidad de ajustar ni la potencia ni el tiempo. Estos alimentos ya han sido probados y pretemperizados locales de la alimentación eléctrica ni los gustos individuales. En caso de que prefiera cocinar los alimentos de una manera diferente, utilice el método de Potencia y Tiempo que aparece en la página 7.

**Ejemplo: Para cocinar 300g Entradas congelados**































1.		• Seleccione la categoría deseada.
2.		• Seleccione porciones/peso. ► Verifique el peso en la <b>Ventana de Visualización</b> .
3.		• Presione <b>Encender</b> . ► Aparece el tiempo de cocción. La <b>Ventana de Visualización</b> realiza una cuenta regresiva..

DESAYUNO	ALIMENTOS	CANTIDAD/PESO	SUGERENCIAS
Desayuno	1. Avenas	0,5, 1 tazas	Siga las instrucciones del fabricante para cantidades de líquido, cubierta o mezclado.
	2. Bebidas	1, 2 tazas	Siga las instrucciones del fabricante para cantidades de líquido, cubierta o mezclado.
	3. Tocino	4 rebanadas (90-110 g) 6 rebanadas (135-165 g) 10 rebanadas (230-270 g) 14 rebanadas (330-370 g)	Use un plato rígido. Cubralo con toallas de papel. Si el bacon no se cocina a su gusto, continúe calentándolo añadiendo más tiempo.
Comida	4. Sopa	1, 2 tazas	Siga las instrucciones del fabricante para cantidades de líquido, cubierta o mezclado.
	5. Pizza Congelada	110, 225 g	Siga las instrucciones del fabricante.
Cena	6. Piesas de Pollo	170, 340, 500, 680 g	Ponglas con la piel hacia arriba, cubralas con plástico de cocina.
	7. Carne Molida	450, 900 g	Separela en pequeñas porciones un plato de Cristal. Cubrala con plástico de cocina. Después de 2 "beeps" voltee la carne. El jugo debe ser transparente.
8. Alimentos Congelados		225, 300, 600, 900 g	Siga las instrucciones del fabricante. No agregue sal hasta después de la cocción. Si necesita más tiempo, continúe cocinando de forma manual.
9. Papas		1, 2, 3, 4 piesas (170-225 g)	Pique la cascara a con un tenedor.
10. Vegetales Fresco		110, 225, 340, 450 g	Todas las piesas deben ser del mismo tamaño. Agregue agua, cubralo con una tapa o plástico.
11. Vegetales Congelados		170, 300, 450 g	Siga las instrucciones del fabricante. No agregue sal hasta después de la cocción. Use menos agua que la recomendada.
12. Arroz		0,5, 1, 1,5 tazas	Use agua caliente en un recipiente para microondas. Cubralo (debe tener ventilación).

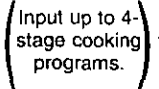
# GUIA RAPIDA DE OPERACIÓN

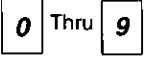
Característica	Como Opera
Para Poner el Reloj en la Hora	 →  a  →  Presione.                      Registre la hora o día.                      Presione.
Para Ajuste de Potencia y Tiempo	 →  a  →  Seleccione potencia.      Establezca el tiempo de cocción.      Presione.
Para Cocinar usando el Pulsador de Palomitas	 →  Registre el peso del paquete.                      Presione.
Minuto Automático	 (hasta a 10) →  Presione.
Para Descongelar usando el pulsador Descongelación Turbo Inverter	 →  a  →  Presione.                      Fije el peso.                      Presione.
Para Recalentamiento usando el pulsador Recalentamiento Automático	 →  Seleccione porciones (1-4).                      Presione.
Para Cocinar usando el Pulsador Auto Cocción	eg.  →  →  Seleccione la categoría.      Seleccione porciones/peso.      Presione.
Para Usar como en temporizador de cocina	 →  a  →  Presione.                      Presione.
Para Establecer el tiempo de Permanencia	(Registre el programa de Cocción deseado.) →  →  a  →  Presione.                      Presione.
Para Establecer Inicio de Efecto Retardado	 →  a  → (Registre el programa de Cocción deseado.) →  Presione.                      Presione.

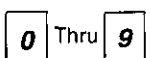
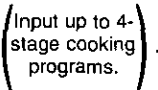
# QUICK GUIDE TO OPERATION

Feature	How to Operate		
To Set <b>Clock</b> (☛ page 7)	 Press.	 Enter time of day.	 Press.
To Cook using <b>Quick Min</b> Pad (☛ page 7)	 (up to 10 min.)		 Press.
To Cook using <b>Popcorn</b> Pad (☛ page 8)	 Press to select weight.		 Press.
To Defrost using <b>Inverter Turbo Defrost</b> Pad (☛ page 8)	 Press.	 Set weight.	 Press.
To reheat using <b>Auto Reheat</b> Pad (☛ page 10)	 Press to select serving (1-4).		 Press.
To use <b>Child Safety Lock</b> (☛ page 10)	 To Set: Press 3 times.	 To Cancel: Press 3 times.	
To Cook using <b>Inverter Auto Cooking</b> Pads (☛ page 10-11)	eg.  Select Category.	  Select Serving/Weight.	  Press.
To Use as a <b>Kitchen Timer</b> (☛ page 12)	 Press.	 	 Press.
To Set <b>Stand Time</b> (☛ page 12)		 Press.	  Press.
To Set <b>Delay Start</b> (☛ page 12)	 Press.	 	  Press.